

# Coils Showcase

Create Scroll Work for Borders and Edge to Edge

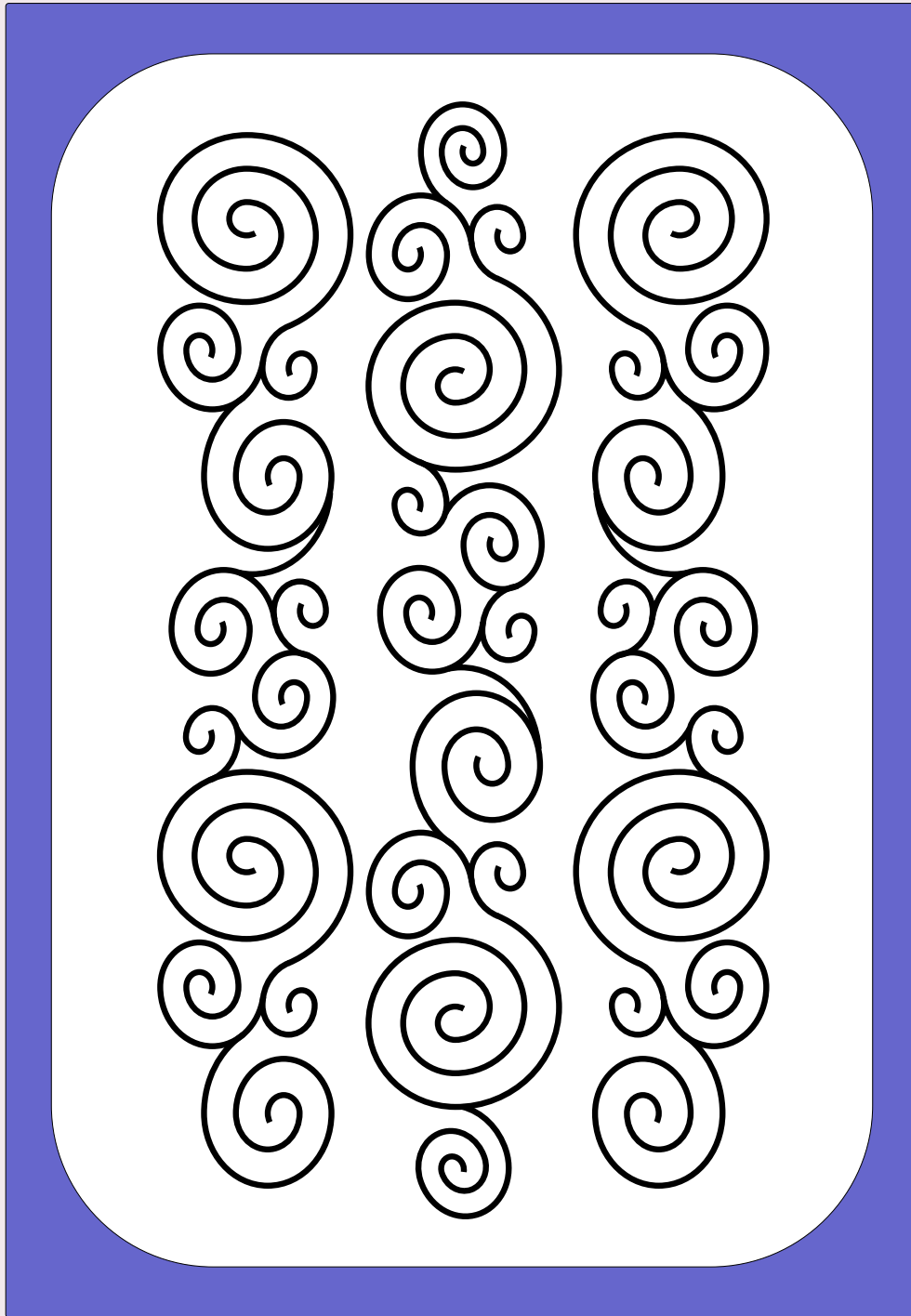
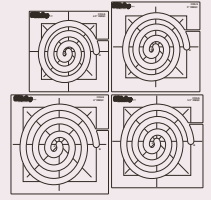

**SCROLL WORK**  
Template Orientation Chart

Refer to this Orientation Chart when determining template placement for the each Scroll. Addition of Stable Tape to both sides of the template is recommended.

The following pages include diagrams to complete the three rows of the SCROLL WORK pattern as shown on front cover. An orientation number (O-1, O-2, O-3 or O-4) is assigned to each of the four optional template layouts. The suggested Template Size (T-4.5, T-5, T-5.5, or T-6) for each scroll unit in the layouts is presented in the diagrams on following pages.

Optional layouts including multiple rows and combinations are shown on the last page of the instructions.

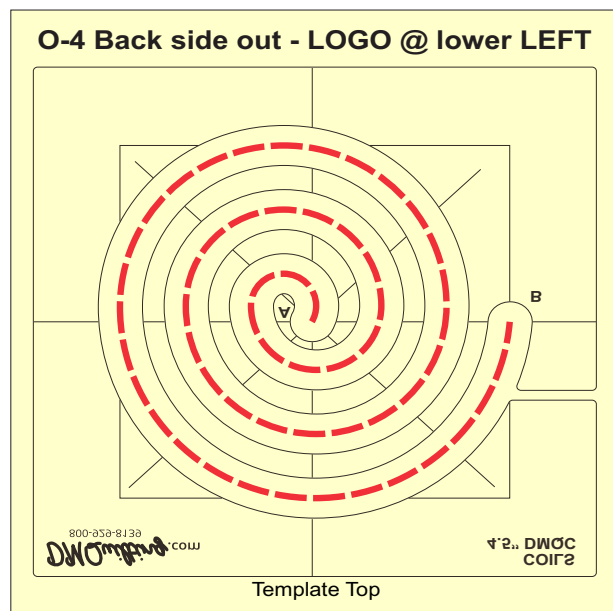
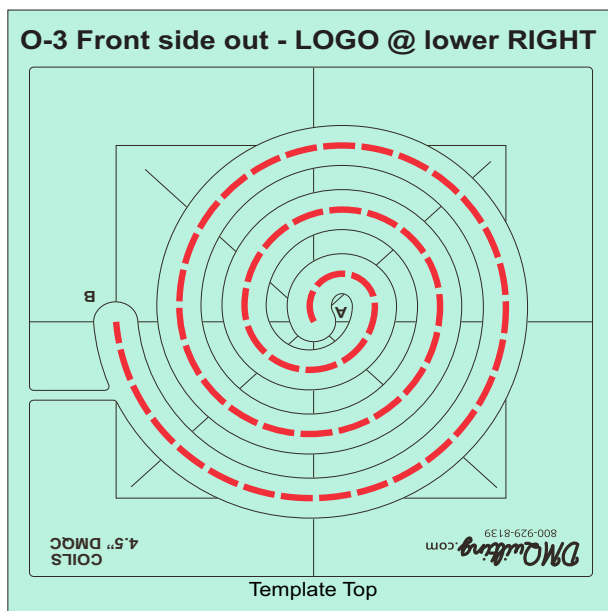
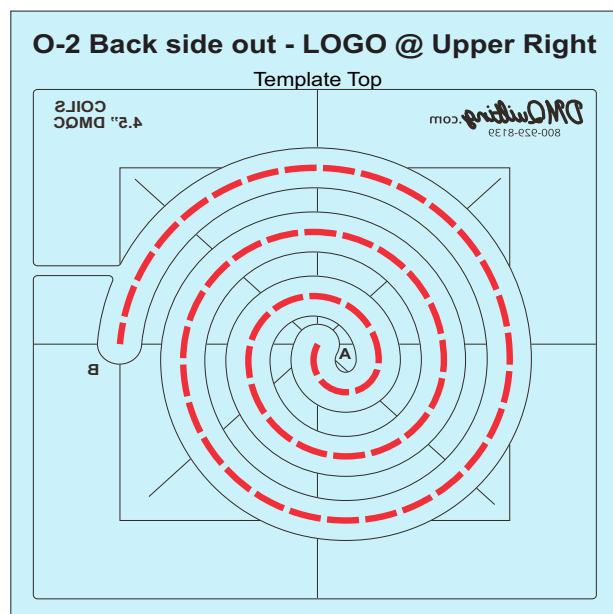
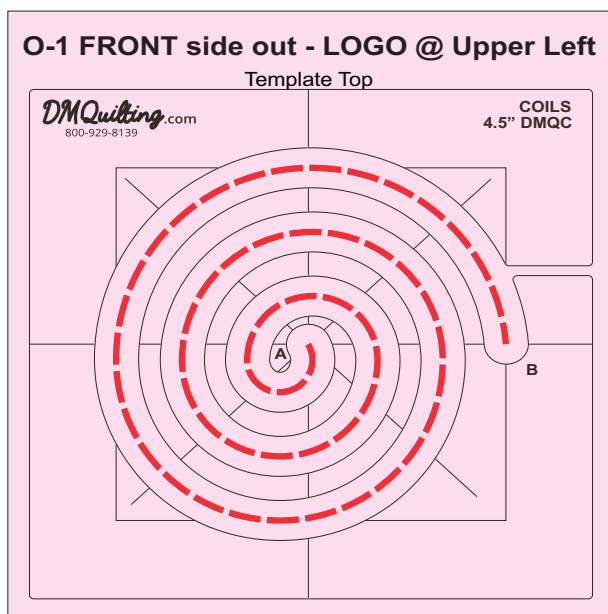

# Coils Showcase

## Scroll Work using COILS Templates

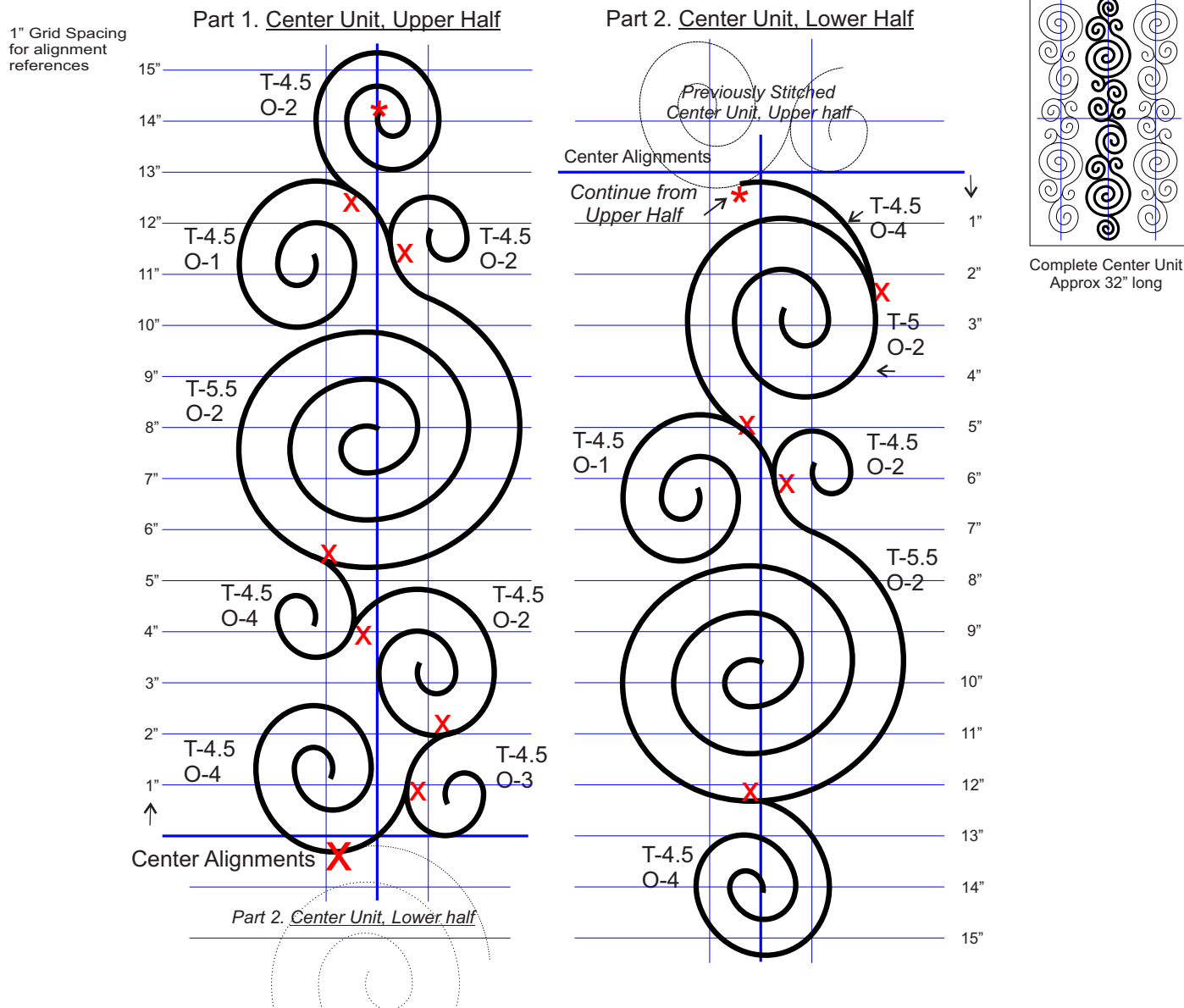

Prepare quilting area of at least 18"x34"+ as this design is approximately 32" long.  
(Overall size adjustments can be made by reducing the number of scrolls or sizes used.)

Lightly mark a center line both vertically and horizontally. Mark lines 6" to the Left & Right of the vertical center line.

- Additional marking of a 1" grid, at these 3 vertical lines, is helpful to calculate alignment and position the templates for each scroll unit. The Basic Marker will provide accuracy and aid in this process
- Review the diagrams above. Many of the scrolls are stitched using only a portion of the template which is positioned to stitch only that part as desired.
- Backtracking is necessary to avoid breaking threads when traveling from one scroll to the next. Small **X** is placed each point where a template position or exchange is made. *Stop with needle down and prepare to continue stitching.*
- Additional rows are completed by using variations of the patterns above and may be flipped or reversed as desired. Refer to complete layout for arrangement. Once the first unit or Center Unit is complete you should have a better understanding of the method involve to accomplish SCROLL WORK.

# Coils Showcase

## Scroll Work using COILS Templates

1" Grid Spacing  
for alignment  
references

### Part 1. Left Unit, Upper Half

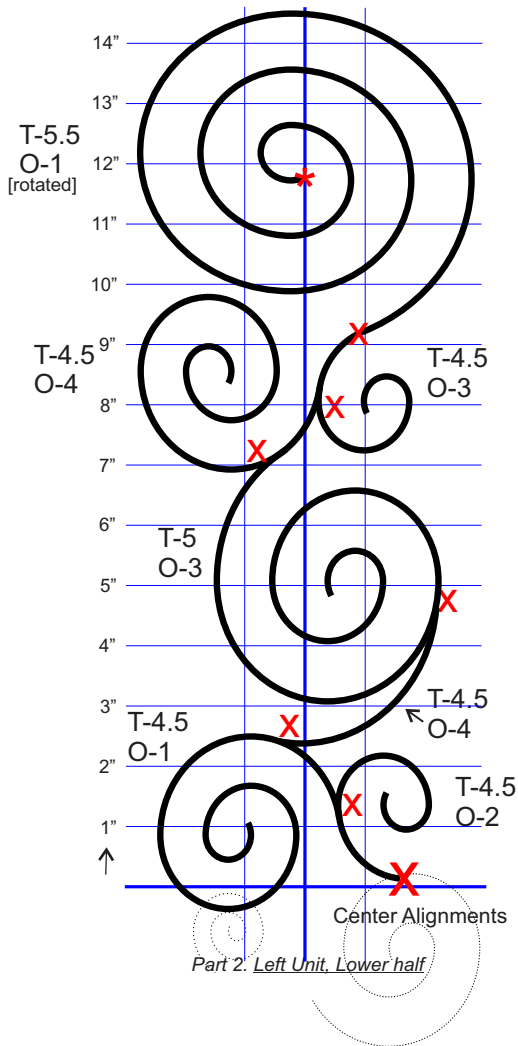

### Part 2. Left Unit, Lower Half

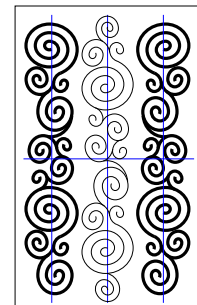
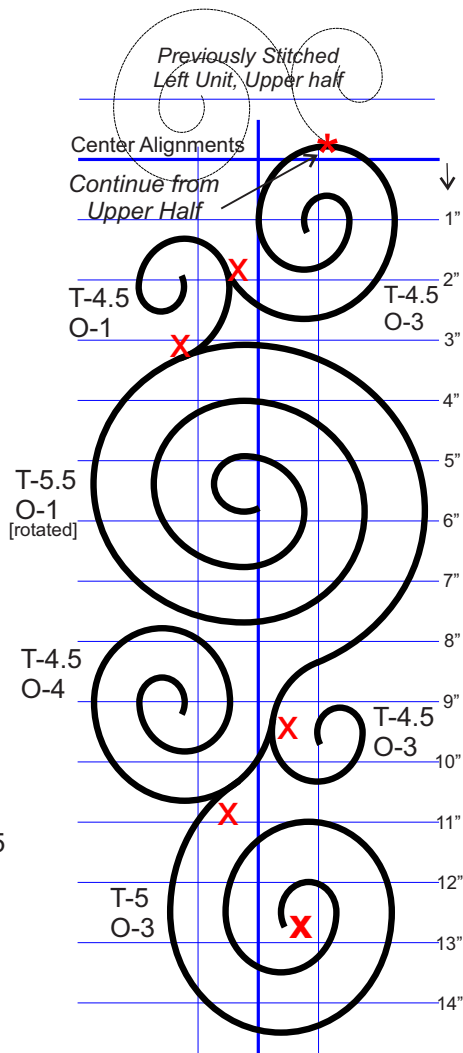

Left & Right Units

Left Unit shown in diagram.

- Additional marking of a 1" grid, at these 3 vertical lines, is helpful to calculate alignment and position the templates for each scroll unit.
- Review the diagrams above. Many of the scrolls are stitched using only a portion of the template which is positioned to stitch only that part as desired.
- Temporary marks can be inserted during stitching to help with next location. Backtracking is necessary to avoid breaking threads when moving from one scroll to the next.
- Small **X** is placed each point where a template position or exchange is made. *Stop with needle down and prepare to continue stitching.*
- Additional rows are completed by using variations of the patterns above and may be flipped or reversed as desired. Refer to complete layout for arrangement.

# Coils Showcase

## Scroll Work using COILS Templates

1" Grid Spacing  
for alignment  
references

### Part 1. Right Unit, Upper Half

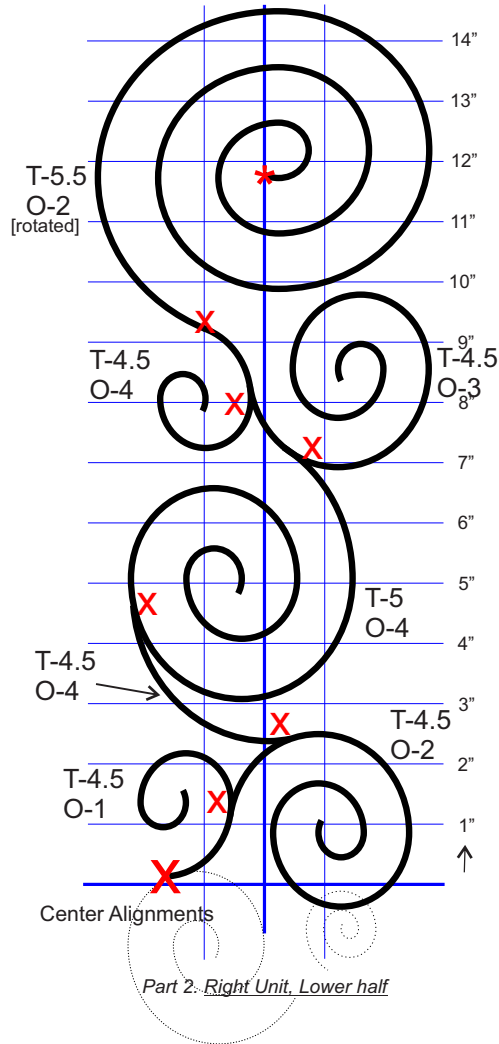

### Part 2. Right Unit, Lower Half

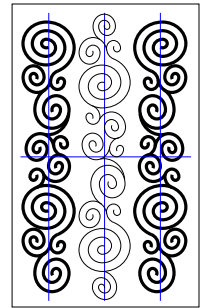
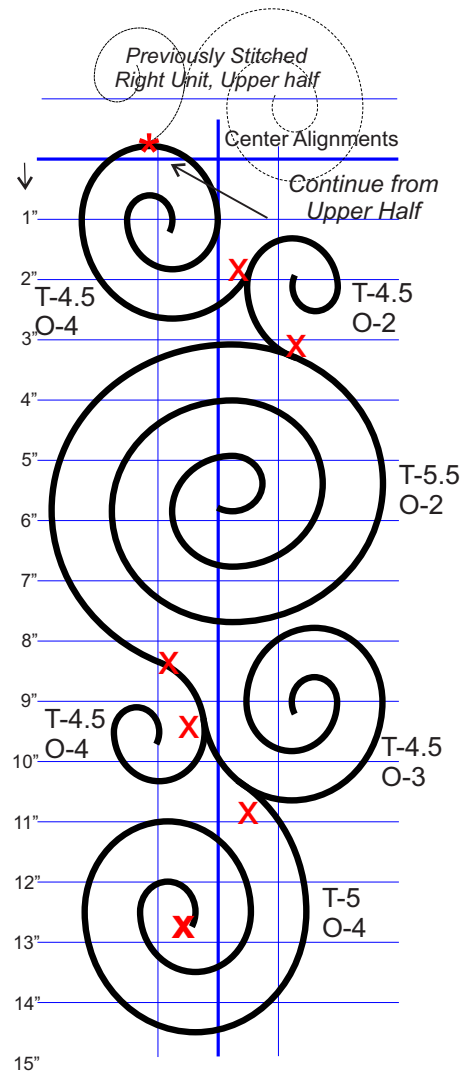

Left & Right Units

Right Unit is a mirror image of the Left Unit.

- Review the diagrams above.
- Many of the scrolls are stitched using only a portion of the template which is positioned to stitch only that part as desired.
- These instructions serve as a general guide as each pattern could be slightly different from the next due to placement, orientation and size of the template selected.

Enjoy your project and please share photos when completed.

Multiple rows for Edge to Edge Quilting

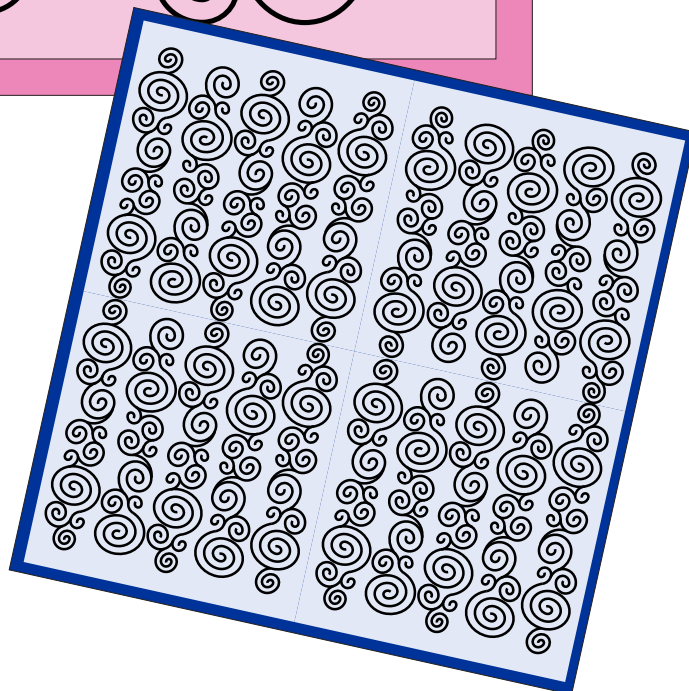
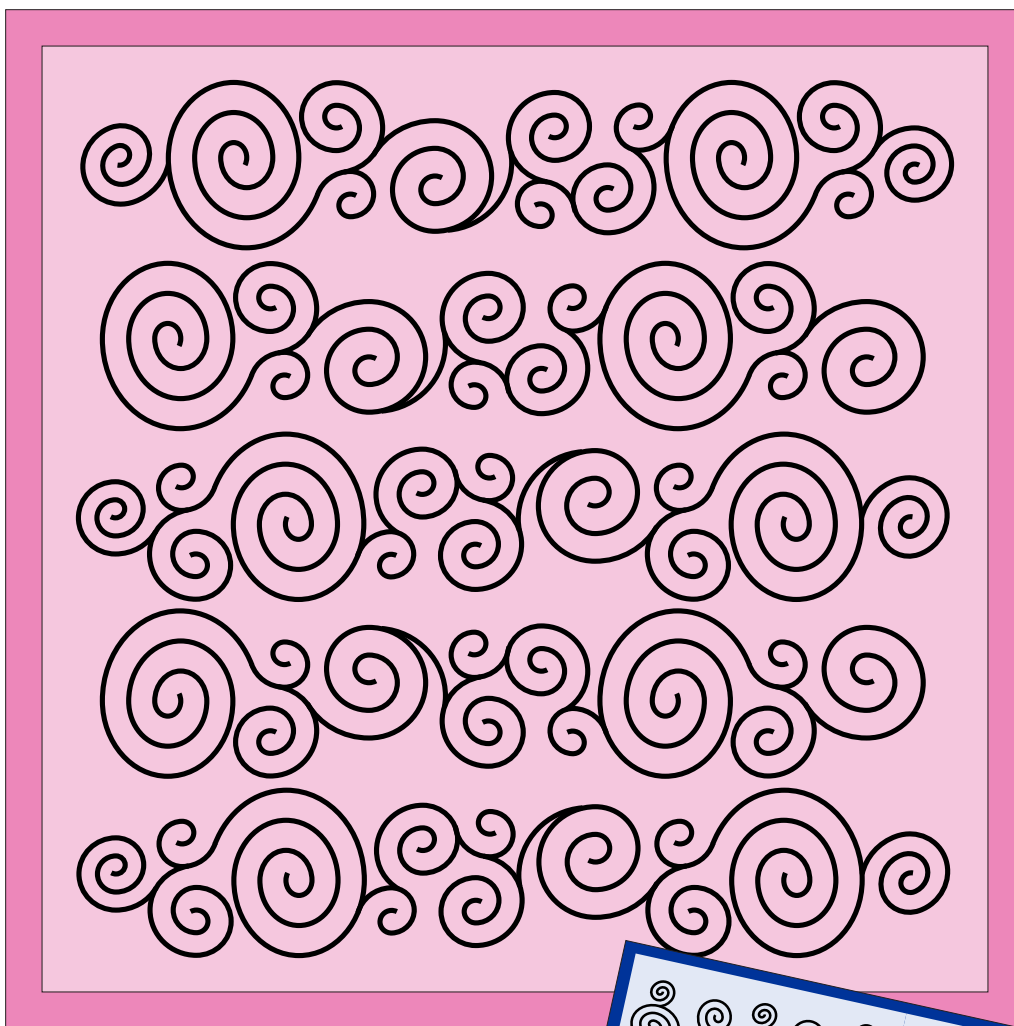

Create your own *Coils Showcase*  
and a SCROLL WORK masterpiece  
for all sizes of projects when combining  
the four template sizes available.